



Bravoled 15" Double Ring Plastic Ceiling Light, 19 watt 1500 Lumen, ETL/cETL & Energy Star

## Specifications

Model#	BL-CL15-19YYZZ
Description	15"LED Round Puff Light,Double Ring
Power	19W
Voltage Input	120Vac,60HZ
Lumen output	1500lm
CCT	2700K
CRI	Ra>80
Housing	Finish Steel base
Application	Indoor Only
Driver	UL certified
Lens	PS
Operating Temp.	-25 C ~ 40 C
IP Rating	IP20
Certificates	ETL/cETL,Energy Star
warranty	3 years
Dimmable	Yes
Product Dimension	15"DIA x4" H (380 x 380 x 100 mm)
Pack Size 1pc	15.6"L x 15.7"W x 4.4"H (395mm x 400mm x 112mm)
Packaging Dimension	28"L x 16.5"W x 16.5"H (710mm x 420mm x 420mm)



## Order Information

Item Number	Description	Power	Voltage Input	Driver	CCT	Lumen Output	Certificates
BL-CL15-19YYZZ	15" Double Ring Plastic Ceiling Light	19W	120Vac	UL Certified	2700K	1500lm	ETL/cETL , Energy Star

## Lux Chart

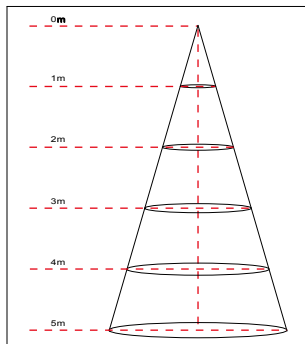

Height	Average Lux (lx)	Light range (dia.)
1M	113.3	343.0cm
2M	28.3	685.9cm
3M	12.6	1028.8cm
4M	7.1	1371.8cm
5M	4.5	1714.7cm

## Photometrics

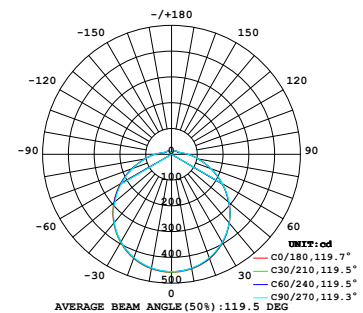

**LM79**  
**LM80**





Bravoled 15" Double Ring Plastic Ceiling Light, 19 watt 1500 Lumen, ETL/cETL & Energy Star

### Product Size

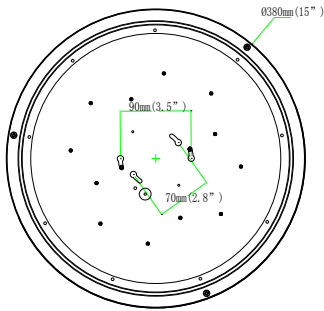
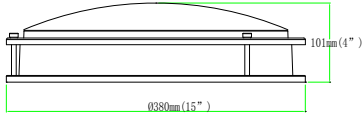

### Packaging

6pcs/CTN G.W.:12.8 kg  
Dimension: 28"L x 16.5"W x 16.5"H (710mm x 420mm x 420mm)

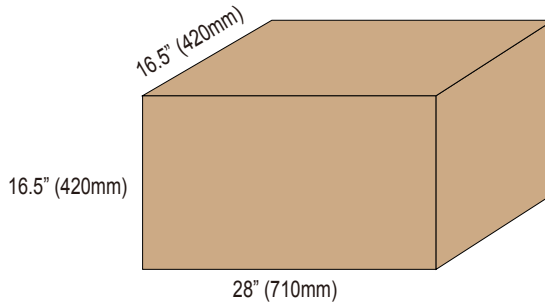

### Container Loading QTY

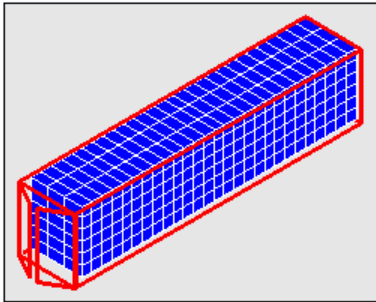

Size	Corton QTY	Product QTY	Volumn	G.W.
40'hq	486 ctn	2916 pcs	64.7m <sup>3</sup>	6220 kg

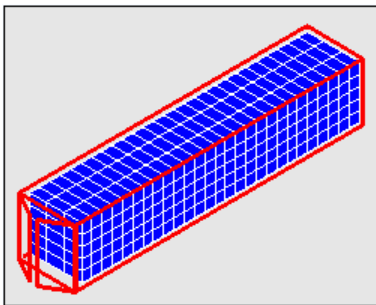

Size	Corton QTY	Product QTY	Volumn	G.W.
40'gp	405 ctn	2430 pcs	53.92 m <sup>3</sup>	5184 kg

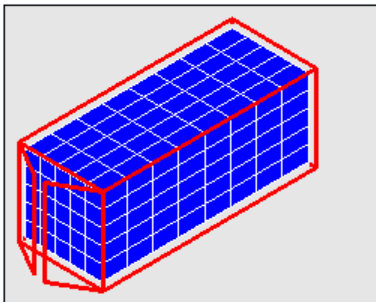

Size	Corton QTY	Product QTY	Volumn	G.W.
20'gp	200 ctn	1200 pcs	26.63 m <sup>3</sup>	2560 kg



**LM79**  
**LM80**

