



Bravoled 26W LED Wall Pack Light, 26 watt 2860 Lumen, ETL/cETL & DLC

Specifications

Model#	BL-WP03A-26W-277-XX
Description	26W LED Wall Pack Light
Power	26W
Voltage Input	100-277Vac,60HZ
Lumen output	2860lm
Color Temperature	3000K,5000K,5700K
CRI	Ra>80
IK Rating	IK07
Power Factor	0.95
Lens	Plastic
Operating Temp.	-25 °C ~ 50 °C
IP Rating	IP65
Certificates	ETL/cETL , DLC
Warranty	5 years
L70 life span	>50000Hrs
Housing Material	Aluminum
Beam Angle	121 Degree
Dimmable	No
Weight	1.2 Kg (2.64 pound)
Installation	Surface mounting with J-BOX
Packaging Dimension	22"L x 10.6"W x 10.2"H (560 x 270 x 260 mm)



Order Information

Item Number	Description	Power	Voltage Input	Dimmable	CCT	Lumen Output	Certificates
BL-WP03A-26W-277-XX	26W LED Wall Pack Light	26W	100-277Vac	No	3000K 5000K 5700K	2860lm	ETL/cETL,DLC

Lux Chart

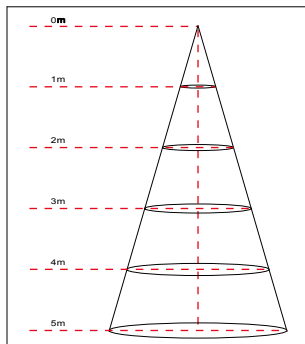

Height	Average Lux (lx)	Light range (dia.)
1M	153.6	292.0cm
2M	38.4	584.0cm
3M	17.1	875.9cm
4M	9.6	1167.9cm
5M	6.1	1459.9cm

Photometrics

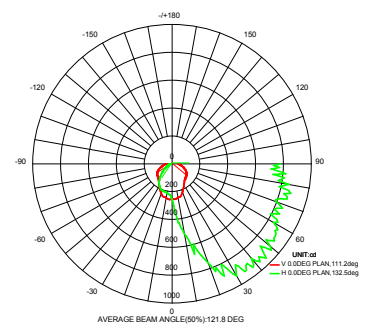

LM79
LM80



Bravoled 26W LED Wall Pack Light, 26 watt 2860 Lumen, ETL/cETL & DLC

Product Size

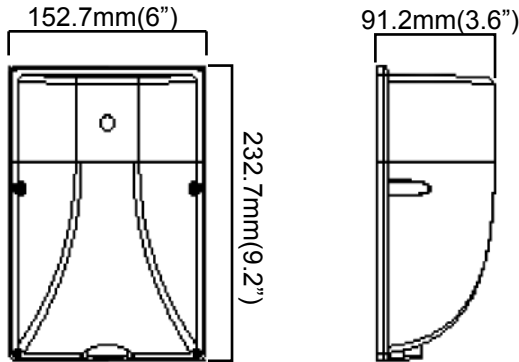

Accessories (optional):



Photocell

Installation

CAUTIONS

READ AND FOLLOW ALL SAFETY INSTRUCTIONS

1. DANGER- Risk of shock- Disconnect power before installation.
2. This luminaire must be installed in accordance with the NEC or your local electrical code.
3. Suitable for wet location and operation in ambient not exceeding 40°C
4. Min 75°C supply conductors.
5. Products are not intended for use in environments containing airborne corrosive airborne corrosive agents such as chemical solvents, cleaners, or cutting fluids.
6. This luminaire is rated for 120V 60Hz only.
7. Replace the Lens if damaged

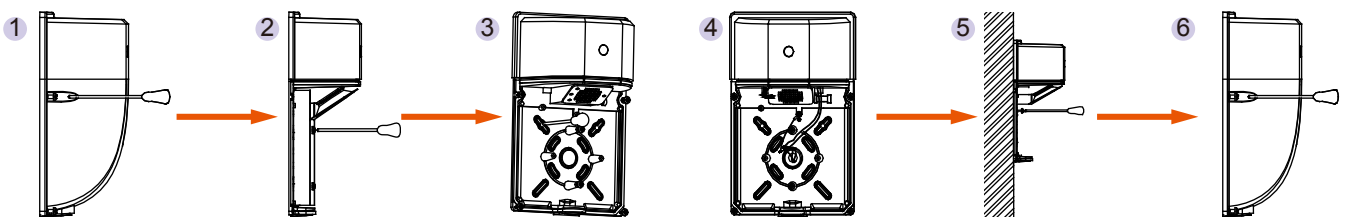

1. Remove the lens by removing the 2 screws securing it to the rear housing and set aside.
2. Loosen two screws enough to allow reflector to slide upward until keyhole in reflector releases from two screws. Remove reflector.
3. Knock out appropriate holes around outlet hole in rear housing and apply the gasket to the back surface of housing and fasten the rear housing to the outlet box using the screws supplied with the outlet box.
4. Complete the wiring to the power source and ground, Using customer supplied 90°C minimum rated wire connectors, make the following electrical connections in the mounting box or junction box:
 - a. Connect the black fixture lead to the voltage supply lead
 - b. Connect the white fixture lead to the neutral supply lead
 - c. Connect the ground lead to the supply ground lead.
5. To ensure rain tight seal, apply silicone caulking around back edges of fixture.
6. Replace reflector.
7. Replace front housing by reversing procedure used to remove it.



LM79
LM80

Bravoled 26W LED Wall Pack Light, 26 watt 2860 Lumen, ETL/cETL & DLC

Packaging

6pcs/CTN G.W.:9.5 kgs Dimension: 22"L x 10.6"W x 10.2"H (560 x 270 x 260 mm)

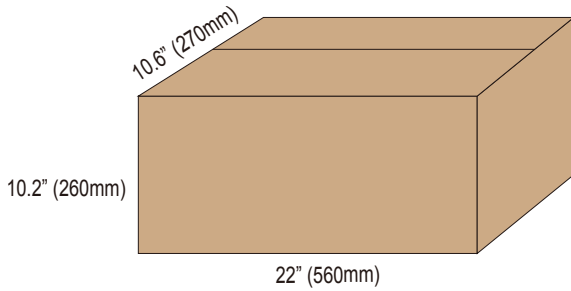

Container Loading QTY

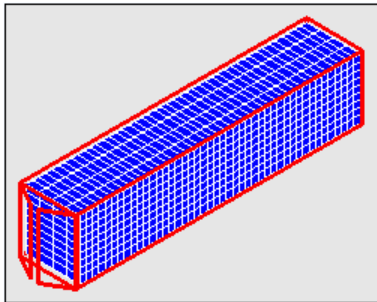

Size	Corton QTY	Product QTY	Volumn	G.W.
40'hq	1584 ctn	9504 pcs	68.26m ³	15048kgs

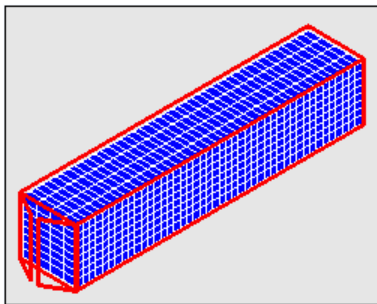

Size	Corton QTY	Product QTY	Volumn	G.W.
40'gp	1408 ctn	8448 pcs	60.67 m ³	13376 kgs

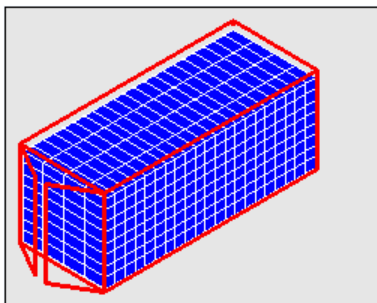

Size	Corton QTY	Product QTY	Volumn	G.W.
20'gp	672 ctn	4032 pcs	28.96m ³	6384kgs