



Bravoled 2x2 Ft LED Troffer Retrofit Kit, 26Watt 2730lm & 3250lm

Specifications

Model#	BL-TRF-22-26W-XTTD
Description	2x2Ft LED Troffer Retrofit Kit
Power	26W
Voltage Input	AC120~277V 50~60HZ
Efficacy	105 Lm/w & 125 Lm/w
Lumen output	2730lm & 3250lm
CRI	Ra>80
Housing Finish	Steel base with white powder coating
Application	Indoor Only
Lens	Frosted diffuse PC lens
Operating Temp.	-20 C ~ 55 C
IP Rating	IP20
Certificates	ETL/cETL(file# 4007551), DLC
warranty	5 years
Life Span	50,000 hours
Dimmable	No
Item Weight	4.1 Kg (9.02 lbs)
Product Dimension	For 2'X2' troffer (533.4 x 533.4mm)
Pack Size	1pc
Packaging Dimension	24.4"L x 24.4"W x 3"H (619.76x619.76x76.2 mm)



Order Information

Item Number	Description	Power	Voltage Input	Dimmable	CCT	Lumen Output	Certificates
BL-TRF-22-26W-XTTD	2x2Ft LED Troffer Retrofit Kit	26W	120~277Vac	Optional	4000k 5000k	2730lm 3250lm	ETL/cETL, DLC

Lux Chart

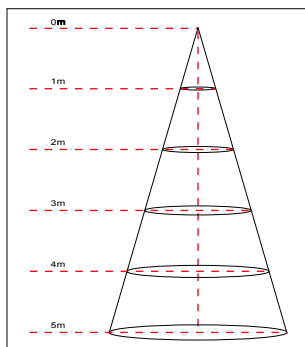

Height	Average Lux (lx)	Light range (dia.)
1M	194.8	332.9cm
2M	48.7	665.7cm
3M	21.7	998.6cm
4M	12.2	1331.4cm
5M	7.8	1664.3cm

Photometrics

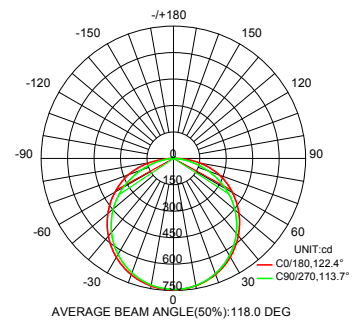

LM79
LM80



Bravoled 2x2Ft LED Troffer Retrofit Kit, 26Watt 2730lm & 3250lm

Dimensions and Pictures

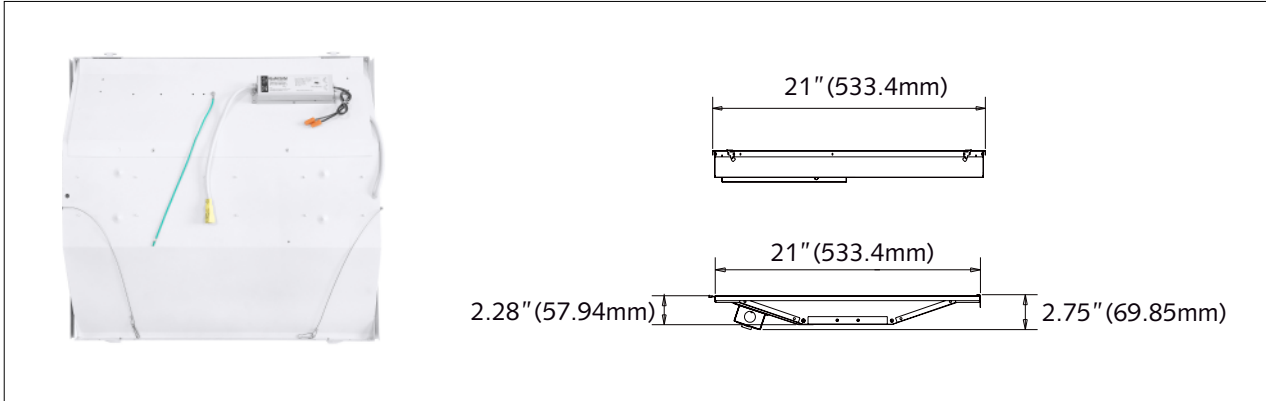

Accessories (optional)

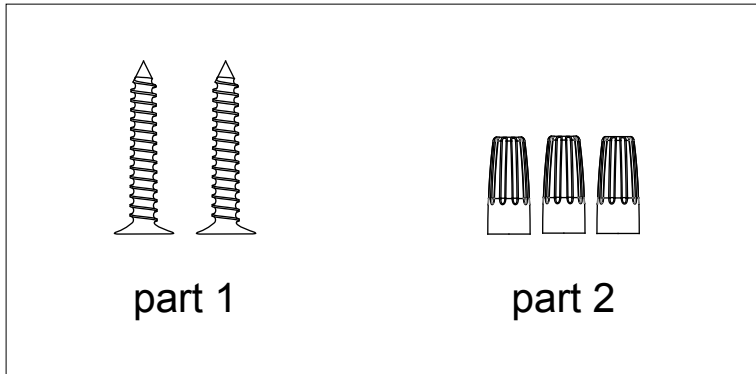

Accessories package List

Part	Description	Quantity
1	self-tapped screw M4*30	2
2	Wire Nuts	*1or3

Note:

3 wire nuts for dimmable version, 1 wire nut for non-dimmable version.



LM79
LM80



Bravoled 2x2 Ft LED Troffer Retrofit Kit, 26Watt 2730lm & 3250lm

Packaging

1pc/CTN G.W.: 5.63 kg Dimension: 24.4"L x 24.4"W x 3"H (619.76x619.76x76.2 mm)

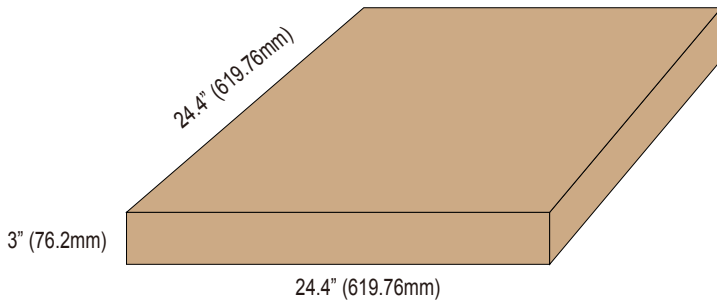

Container Loading QTY

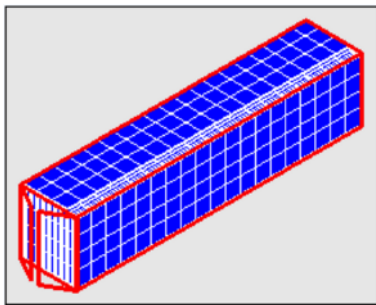

Size	Corton QTY	Product QTY	Volumn	G.W.
40'hq	2166 ctn	2166 pcs	73.93m ³	12194.58kg

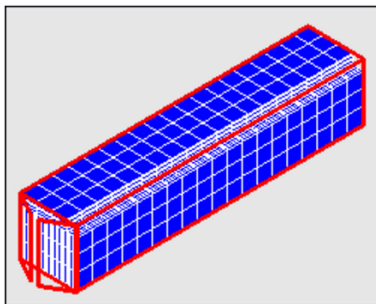

Size	Corton QTY	Product QTY	Volumn	G.W.
40'gp	1824 ctn	1824 pcs	62.26 m ³	10269.12 kg

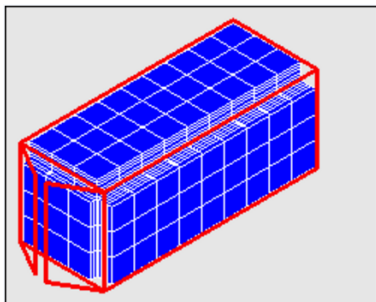

Size	Corton QTY	Product QTY	Volumn	G.W.
20'gp	882 ctn	882 pcs	30.11m ³	4965.66kg



LM79
LM80