



Bravoled 2x4Ft LED Troffer Retrofit Kit, 40Watt 4200lm & 5000lm

Specifications

Model#	BL-TRF-24-t-XTTD
Description	2x4Ft LED Troffer Retrofit Kit
Power	40W
Voltage Input	AC120~277V 50~60HZ
Efficacy	105 Lm/w & 125 Lm/w
Lumen output	4200lm & 5000lm
CRI	Ra>80
Housing Finish	Steel base with white powder coating
Application	Indoor Only
Lens	Frosted diffuse PC lens
Operating Temp.	-20 °C ~ 55 °C
IP Rating	IP20
Certificates	ETL/cETL(file# 4007551), DLC
warranty	5 years
Life Span	50,000 hours
Dimmable	0~10V dimmable
Item Weight	6.8 Kg (14.96 lbs)
Product Dimension	For 2'X4' troffer (533.4 x 1185 mm)
Pack Size	1pc
Packaging Dimension	48.4"L x 24.4"W x 3"H (1229.36 x 619.76 x 76.2 mm)



Order Information

Item Number	Description	Power	Voltage Input	Dimmable	CCT	Lumen Output	Certificates
BL-TRF-24-40W-XTTD	2x4Ft LED Troffer Retrofit Kit	40W	120~277Vac	Optional	4000k 5000k	4200lm 5000lm	ETL/cETL, DLC

Lux Chart

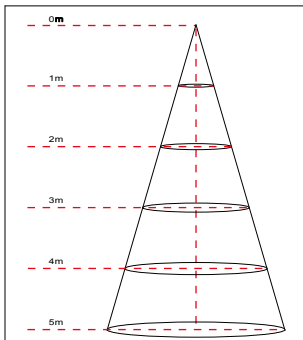

Height	Average Lux (lx)	Light range (dia.)
1M	304.6	332.2cm
2M	76.1	664.4cm
3M	33.9	996.6cm
4M	19.0	1328.8cm
5M	12.2	1660.99cm

Photometrics

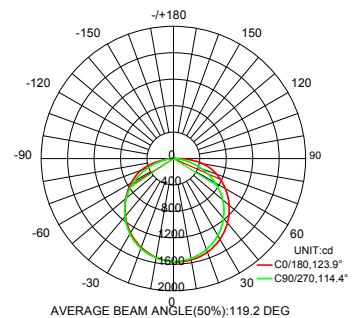

LM79
LM80



Bravoled 2x4Ft LED Troffer Retrofit Kit, 40Watt 4200lm & 5000lm

Dimensions and Pictures

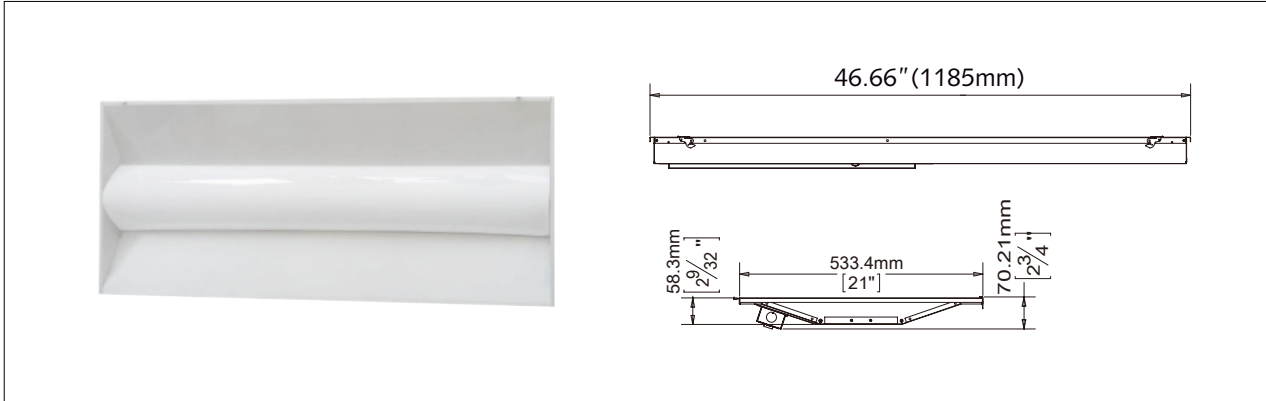

Accessories (optional)

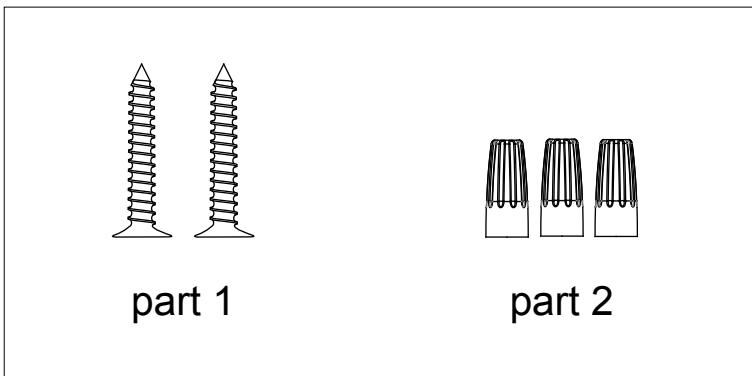

Accessories package List

Part	Description	Quantity
1	self-tapped screw M4*30	2
2	Wire Nuts	*1or3

Note:

3 wire nuts for dimmable version, 1 wire nut for non-dimmable version.



LM79
LM80



Bravoled 2x4Ft LED Troffer Retrofit Kit, 40Watt 4200lm & 5000lm

Packaging

1pc/CTN G.W.: 9.36 kg Dimension: 48.4"L x 24.4"W x 3"H (1229.36 x 619.76 x 76.2 mm)

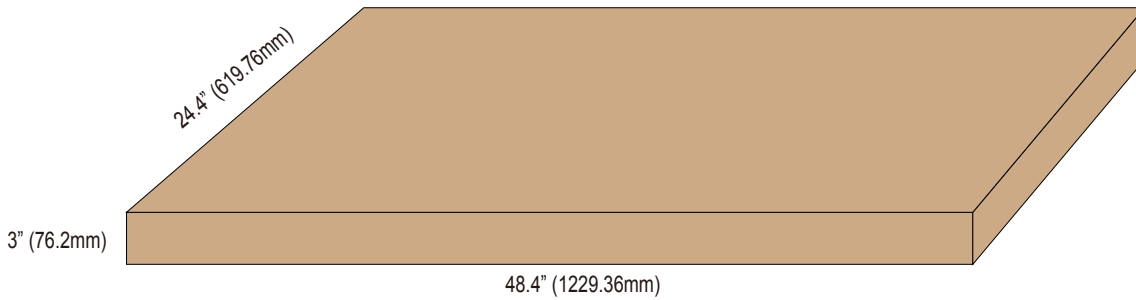

Container Loading QTY

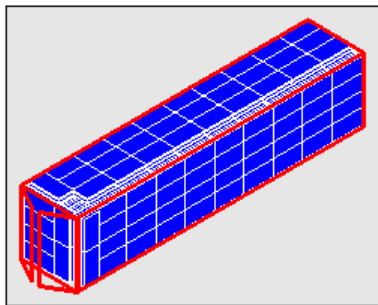

Size	Corton QTY	Product QTY	Volumn	G.W.
40'hq	1098 ctn	1098 pcs	72.91m ³	10277.28kg

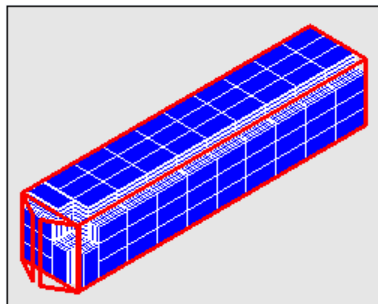

Size	Corton QTY	Product QTY	Volumn	G.W.
40'gp	941 ctn	941 pcs	62.48 m ³	8807.76 kg

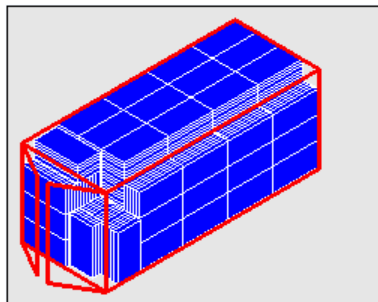

Size	Corton QTY	Product QTY	Volumn	G.W.
20'gp	450 ctn	450 pcs	29.88m ³	4212kg



LM79
LM80