

# LHB-4FTN-196W-P5KN

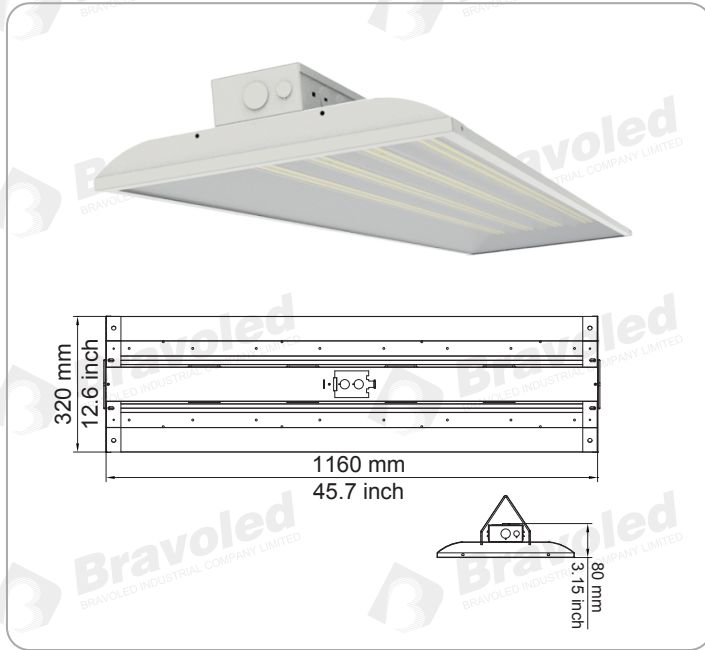

### Driver Info

Type:	Constant Current
120V:	Yes
277V:	Yes
480V:	No
Input Watts:	196W
Efficiency:	86%

### LED Info

Watts:	196W
Color Temp:	5000K
Color Accuracy:	80CRI
L70 Lifespan:	50000
Lumens:	29400
Efficacy:	150LP/W

This linear high-bay delivers versatility and ultra-high efficiency. Available in 75, 98, 150, 196 and 296 Watt versions for mounting heights ranging from 15 to 50 feet.

Color: White

Weight: 15lbs(6.8Kg)

## Technical Specifications

### Listings

#### ETL Listing:

Suitable for damp locations.  
ETL code: 4007551

#### DLC Listed

This product is on the Design Lights Consortium(DLC) Qualified Products List and is eligible for rebates from DLC Member Utilities.

#### IESNA LM-79 & IESNA LM-80 Testing:

This product has been tested by an independent laboratory in accordance with IESNA LM-79 and 80, and have received the Department of Energy" Lighting Facts" label.

### Electrical

#### Driver:

Constant Current, Class 2, 100-277Vac, 50/60HZ, 0.95Amp@100Vac, XIEZHEN Brand.

#### THD:

<20%

#### Power Factor:

>0.95

#### Dimming Type:

Non Dimmable (default)  
0~10 Dimmable (Optional): requires separate 0~10V DC dimming circuit, dimming as low as 10%

#### Emergency Battery Backup:

Optional

### LED Characteristics

#### Lifespan:

50,000-hour LED lifespan based on IES LM-80 results and TM-21 calculations.

#### LEDs:

Long-life, high-efficiency SMD2835, patent free.

#### Color Stability:

Comply with DLC's requirements.

#### Color Uniformity

CCT(Correlated Color Temperature) follows the guidelines of the American National Standard for Specifications for the Chromaticity of Solid State Lighting(SSL) Products, ANSI C78.377-2015.

### Construction

#### Operating Temperature:

-20°C (-4°F) - 55°C (131°F)

#### Housing:

Die formed painted steel

#### Lens:

Frosted PC Cover

#### Reflector:

Specular, high-reflectance aluminum with 95% reflectivity

#### Mounting:

Suspension Mount/Pendant/Surface Mount(J box)

### Finish:

Our environmentally friendly polyester powder coatings are formulated for high-durability and long-lasting color, and contain no VOC or toxic heavy metals

### Green Technology:

Mercury and UV free RoHS compliant components  
Polyester powder coat finish formulated without the use of VOC or toxic heavy metals.

### Other

### 5 Yr Limited Warranty:

Fixture operation and paint finish are covered for a period of 5 years.

# LHB-4FTN-196W-P5KN

## Order Information

LHB	4FTN	Wattage	Efficiency	CCT	N
LHB	4FTN	75W	S:130lm/w	3K:3000K	N:Non-Dimmable
		98W	P:150lm/w	4K:4000K	
		150W		5K:5000K	
		196W			
		296W			
LHB	4FTN				N

## Accessories (optional)

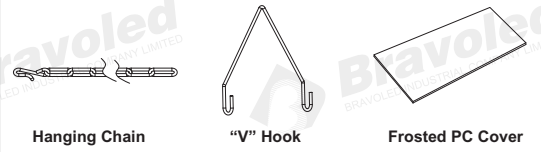

## Installation

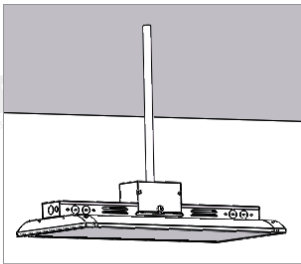

Pendant Mount

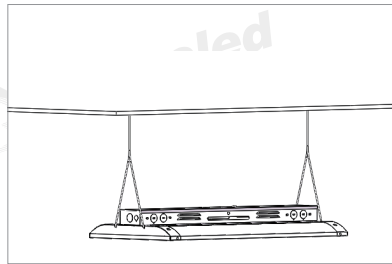

Suspended Mount

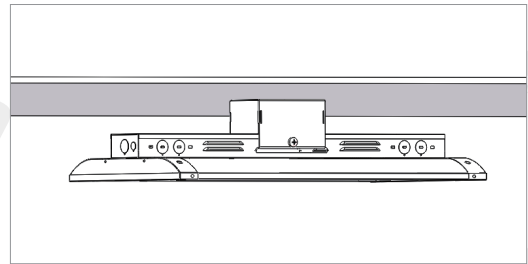

Surface Mount & J-Box Mount

## Lux Chart/Photometrics

1.0m	10618.0 , 8468.9 lx	249.54cm
2.0m	2654.5 , 2117.2 lx	499.07cm
3.0m	1179.8 , 941.0 lx	748.61cm
4.0m	663.6 , 529.3 lx	998.15cm
5.0m	424.7 , 338.8 lx	1247.69cm
6.0m	294.9 , 235.2 lx	1497.22cm
7.0m	216.7 , 172.8 lx	1746.76cm
8.0m	165.9 , 132.3 lx	1996.30cm
9.0m	131.1 , 104.6 lx	2245.84cm
10.0m	106.2 , 84.7 lx	2495.37cm

Max , Ave      Beam angle of C0plane102.38

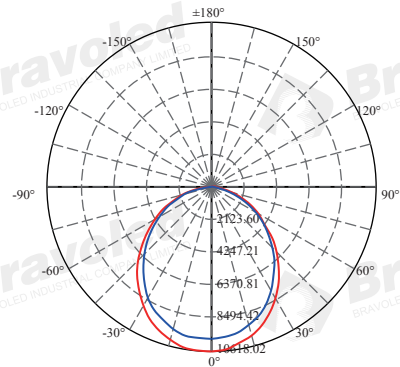

## Packaging

1pcs/CTN    G.W.:7.7 kg  
 Dimension: 46.8"L x 13.8"W x 3.5"H (1188mm x 350mm x 88mm)

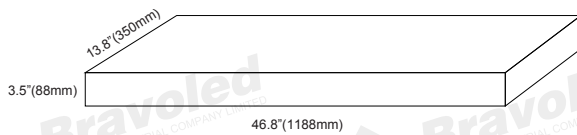

40'hq	1708 pcs
40'gp	1518 pcs
20'gp	708 pcs